

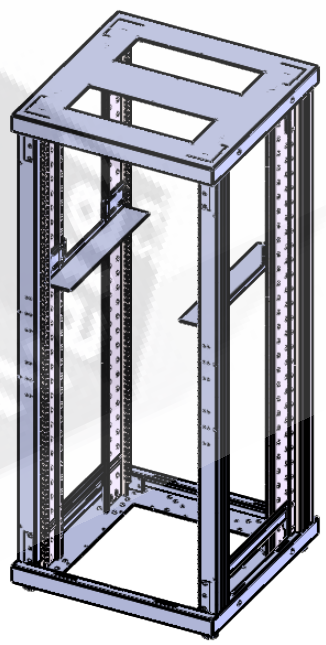

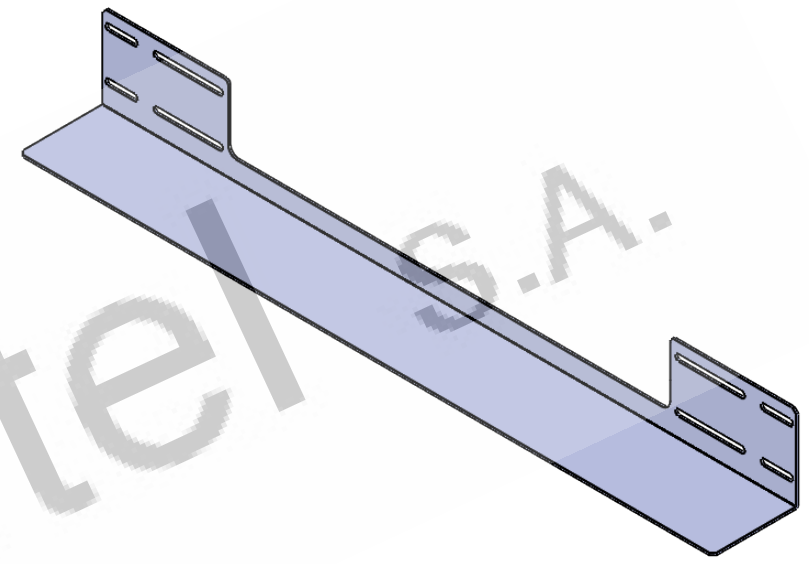

PROPRIETARY AND CONFIDENTIAL  
 CONTAINED IN THIS DRAWING IS THE SOLE PROPERTY OF OLIVETEL S.A.  
 ANY REPRODUCTION IN PART OR AS A WHOLE WITHOUT THE WRITTEN PERMISSION OF  
 OLIVETEL S.A. IS PROHIBITED.  
 PROPRIETARY DATA; ALL RIGHTS RESERVED.

PROPRIEDADE E CONFIDENCIALIDADE  
 O CONTEÚDO DESTA DESENHO É EXCLUSIVA PROPRIEDADE DA OLIVETEL S.A.  
 QUALQUER REPRODUÇÃO PARCIAL OU TOTAL SEM O CONSENTIMENTO ESCRITO DA  
 OLIVETEL S.A. É PROIBIDA.  
 COMUNICADO COMO SEGREDO EMPRESARIAL; RESERVADOS TODOS OS DIREITOS.

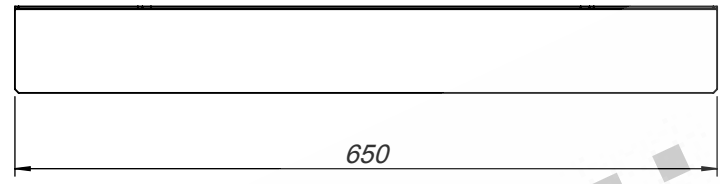
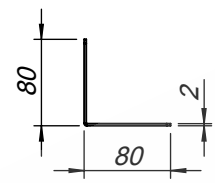
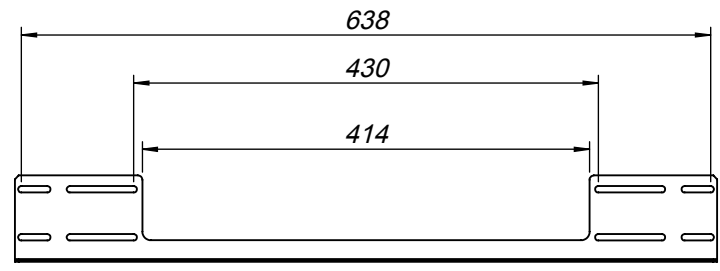

|   |   |   |
|---|---|---|
|  <b>olivetel</b> s.a.<br>Departamento de Projecto<br>Project Department<br>Projekt Abteilung<br><a href="http://www.olivetel.pt">www.olivetel.pt</a> | <b>PROJECTO:</b><br>Project/Projekt:<br>SL  | <b>MATERIAL:</b><br>Werkstoff:<br>Ver Encomenda                             |
|   | <b>DESIGNAÇÃO:</b><br>Designation/Benennung:<br>Vistas Gerais   | Tratamento de Superfície<br>Surface Finishing/Oberflaeche:<br>Ver Encomenda |
| <b>ESCALA:</b> 1:50<br>Todas as dimensões em mm<br>Units / Einheit: mm  | <b>DESENHO Nº:</b><br>Drawing Nº/Z. Nr.:<br>SL.65.UNIV.2U   | <b>TOLERÂNCIAS GERAIS:</b><br>Tolerances:<br>Allgemeintoleranz: DIN 7168-m  |
| <b>PROJECTADO:</b><br>Design by:<br>Projekt:<br>19-06-2018  | <b>DESENHADO:</b><br>Drawn by:<br>Bearb.:<br>FM 19-06-2018  | <b>PESO:</b><br>Weight:<br>Gewicht: 1158.81 gr.                             |
| <b>FORMATO:</b><br>Size/Format: A4  |    | <b>OBSERVAÇÕES:</b><br>Comments:<br>Bemerkung:                              |